

## Short Research Article

# The “Naked Electron”

Robert A. Sizov<sup>1\*</sup>

<sup>1</sup> Individual researcher, doctor of physical and mathematical sciences, Moscow, Russia

Received: October 8, 2019      Accepted: October 15, 2019      Online Published: October 24, 2019  
doi:10.22158/asir.v3n4p257      URL: <http://dx.doi.org/10.22158/asir.v3n4p257>

### **Abstract**

*The true sources of magnetic field, i.e., real magnetic poles (magnetic charges), turned out to be unrecognized in physical science due to the special conditions of their confinement in atoms and substance which are cardinally different from the confinement of electrons. In addition, Maxwell's vicious electromagnetic concept in which electrons moving in atoms and substance were declared as direct sources of the magnetic field played a very negative role in story with confession of real magnetic charges. This concept was the result of the superficial and exceptionally erroneous impression of the Great Physicist from the Oersted's famous experience. However, the world scientific community accepted this erroneous impression as the ultimate truth. Herewith true magnetic poles which are the real structural components of atoms and substances, were “buried alive”. Along with magnetic charges were ignored in physics and of such real spinor particles as true antielectrons, which were replaced by electron vacancies or Dirac holes. It is important to note that the above-recognized unacknowledged, spinor particles, together with electrons, constitute the electromagnetic atomic shells. The world electromagnetic theory, while ignoring the three fundamental particles, was forced to rely solely on the electron, which in modifications of various theoretical surrogates (magnetic moments, electronic vacancies and others) was forced to answer both for itself and for three unrecognized fundamental particles, that is, for two magnetic charges (magneton and antimagneton) and a real antielectron.*

### **Keywords**

*Electrons, magnetic charges (magneton and antimagneton), vortex electromagnetic (gravitational) field, magnetic moments, Dirac monopole, Maxwell electric magnetism*

### **1. Introduction**

The vicious concept of electric magnetism Maxwell's is the result of the superficial and exceptionally erroneous impression of the Great Physicist from the known experience of Oersted (Maxwell, 1873). However, the world scientific community accepted this erroneous impression as the ultimate truth and,

following Maxwell, declared that the moving in substance and atoms the electrons are direct sources of the magnetic field. At the same time, the true sources of the magnetic field, real magnetic poles (magnetic charges), which are the structural components of atoms and substance were “buried alive”. Such theoretical “discoveries” as the curvature of four-dimensional space-time explaining the physics of gravity, the big bang, the journey through “Black holes” in space and time and many others were formed without taking into account the existence of real magnetic charges, since all these compositions adhered to the provisions of Maxwell’s vicious electromagnetic concept.

The physical theory in a “absence” of real magnetic charges and true antielectrons was forced to use such surrogates as the magnetic moments of electrons and electronic vacancies as substitutes for these real particles in compositions of atoms and substance. In addition, any movement of electrons (translational or rotational) was invariably considered as direct source of magnetic field (Robert, 2001; 2015). Electric currents were used even in the theoretical construction of the famous Dirac monopole (Dirac thread) what makes possible to call this monopole as the electrified quasi-particle (Dirac, 1931; Robert, 2018).

The electron which is the main actor in a huge number of existing erroneous physical representations, in addition to its own electric field, was forced by its movement to create a magnetic field, as well as to be responsible for all the observed magnetic manifestations. There are even the theoretical concepts in which by electric particles, and above all the electrons, are attributed with the ability, depending on circumstances, to change the nature of their charges.

The most harmful misconception in physical science, initiated by Maxwell’s flawed electromagnetic concept, is the concept of the electron shell of atoms. The research of the author has shown that real atomic shells are electromagnetic, and not electronic. In addition to electrons in their compositions there are three more fundamental particles: two magnetic (magneton and antimagneton), as well as the true antielectron (Robert, 2016).

**Note.** According to the author’s research magnetic charges in atomic shells are represented by a pair of spinor particles (particle and antiparticle) with magnetic charges  $g^-$  and  $g^+$  under the general condition  $e = g$ , where  $e$  is the electron charge (Robert, 2015; Robert, 2015).

One can only wonder, how theorists managed to more or less successfully replace these three unrecognized spinor particles in physical representations with one electron? The “Himalayas” of theoretical “discoveries” in physics generated by Maxwell’s erroneous electromagnetic concept are striking. The concept of Maxwell can be regarded as a kind of malignant formation in the “body” of physical science the “metastases” of which struck its many areas and directions.

It is important to note that the magnetic field in the Oersted experiment is a vortex field and is determined by the vortex vector  $\text{rot}\mathbf{H}$ . In the concepts of physics with real magnetic charges such a field is formed by a rotating magnetic dipole according to the equation  $k \text{rot}\mathbf{J}_g = \text{rot}\mathbf{H}$ , where  $\mathbf{J}_g$  is the vector of instantaneous current density of magnetic charges, and the expression  $\text{rot}\mathbf{J}_g$  is the circular current of magnetic charges or, in a model representation, is rotating magnetic dipole (Robert, 2015,

2016).

The role of the electronic currents in the process of formation of magnetic field consists exclusively in the organization of circular (eddy) motion of magnetic dipoles in accordance with the equation  $\text{rot} \mathbf{J}_e = \text{rot} \mathbf{J}_g$ , where  $\mathbf{J}_e$  is the density vector of the linear electron current, and  $k$  is the proportionality coefficient.

Thus, the so-called first Maxwell equation ( $\text{rot} \mathbf{H} = \mathbf{J}_e$ ) actually describes two different physical processes:

- 1) formation of eddy current of magnetic charges (rotating magnetic dipoles) by means of an electric current in a conductor ( $\text{rot} \mathbf{J}_e = \mathbf{J}_g$ );
- 2) formation of a vortex magnetic field  $\text{rot} \mathbf{H}$  as a result of the vortex motion of magnetic dipoles ( $\text{rot} \mathbf{J}_g = \text{rot} \mathbf{H}$ ).

The results of the author's research allowed him to assert that the main reason that has prevented reliable detection and, therefore, recognition of real magnetic charges, as well as true anti-electrons, for more than 100 years, are their special confinement conditions in substance, which are radically different from the confinement of electrons. The fact is that the forces holding these unrecognized particles in the structures of substance increase with increasing internal energy of the body, which practically excludes the possibility of their separation and research in conditions of high-energy physics. Experimental "communication" with individual magnetic charges and true antielectrons in the compositions of substance is possible only at low temperatures, for example, under superconductivity conditions (Robert, 2017).

In Figure shows the scheme disposition of levels electrons, magnetic charges and true antielectrons in the condensed state of substance on the energy scale. It is well known that the electronic levels are located in a potential **pit** and for going out of an electron in a free state is necessary to increase the internal energy of substance, for example, to heat him.

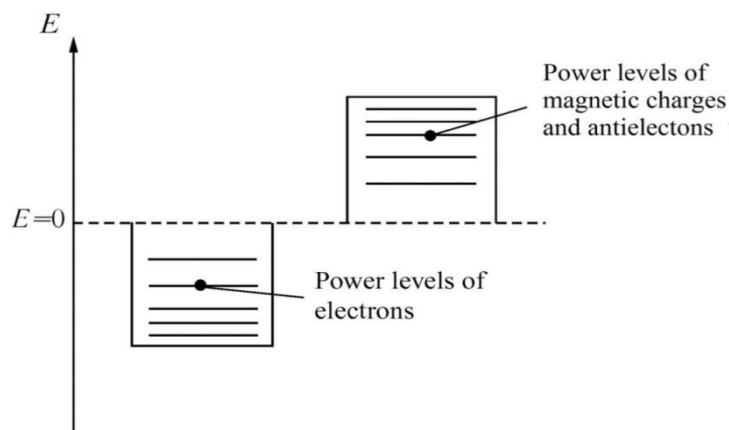

**Figure. The Location on the Scale of Energy (in the Condensed State of Substance) Levels of Electrons (in the Potential "Pit") and Magnetic Charges with True Antielectrons (under the Potential "Cupola")**

Unlike electrons, the energy levels of true antielectrons, as and the levels of magnetic charges are under potential **cupola** and for the implementation of the free state of these particles need to cooled substance, that is, to reduce its internal energy. The deep stages of cooling there is arises the superconductivity effect what is an evidence of transition part of the magnetic charges, as and antielectrons into the condition free from bonds with the lattice of superconductor. Here we mean the charges populating the potential and real conduction zones in the conductors. In this case, the electric current passes through the superconductor without resistance, since the free magnetic charges which revolve around the current lines does not experience friction against lattice of the superconductor. Any the energetic pumping of the substance (radiation, heat, etc.), will push magnetic charges on a higher energy levels that is accompanied by sharp increase in the electrical resistance of the conductor.

Thus, under “sanctions” confinement, i.e., under the **cupola** (see Figure), are three fundamental spinor particles, of the four existing in the atomic shells, i.e., a pair of magnetic particles with charges  $g^-$  and  $g^+$  and true antielectron with a charge of  $e^+$ . Recall that the magnitude of the charges particles in the atomic shells meet the condition:  $e = g$ . Paradoxically, but these three fundamental spinor particles still not recognized by the modern physical science.

As were noted above, real magnetic charges were substituted in theory on such physical surrogates as the magnetic moments (of the electrons, neutrons and so on). “Theoretical fate” of the true antielectrons, i.e., the real particles of Antimatter were “solved” by P. Dirac, who “buried” these particles under such theoretical surrogates as the electron vacancies or electron holes (Dirac, 1930; Robert, 2015).

The results of the experiments of F. Ehrenhaft and the present author in which the real magnetic charges were observed in structures of atoms and substances, prove that the concept of electric magnetism Maxwell is deeply erroneous, and the cardinal change of physical priorities is the super-present task today (Ehrenhaft, 1942; Robert, 2008).

Physical science, freed from the flawed concept of Maxwell, will free and the “unhappy” electron from its unusual functions and, necessarily, will present to humanity to innovations in the form of practically useful physical effects. The publication (Robert, 2019) presents a short list of such innovations developed by the author, including: electromagnetic (vortex) nature of the gravitational field, the effects of gravitational levitation and intra-atomic gravitational shielding/lensing (IAGS/L). The effect of gravitational levitation will, for example, allow a person to go out into space without using jet propulsion. The IAGS/L effect largely determines the physics of such fundamental manifestations as chemical bonding, nuclear forces, and radioactivity (Robert, 2018; Robert, 2019).

Grandiose punctures in physics, caused by the introduction of the vicious concept of Maxwell in the minds, are not limited to the above. The Appendix to the article presents a brief list of the main erroneous misconceptions in physical science, which lie as the dead weight in the path of positive development both of physics so and in the natural sciences, as a whole.

## 2. Conclusion

The paradoxical situation with real magnetic charges and true antielectrons that has developed in physics and described in this article is the result of the lack of timely experimental detection of these real spinor particles in structures substance. Of course, such detection is extremely difficult due to the special conditions of confinement of these particles in the substance. At the same time, the author succeeded in the period 1968-1992 to put a series of very laborious experiments that confirmed his original version about the existence of real magnetic charges as structural components of atoms and substance.

As for Maxwell, then he, back in 1873, he formulated his concept, relying solely on the experience of Oersted. It is important to note that according to the historians of physical science, Maxwell himself considered his electromagnetic concept as the first approach to reality. Unfortunately, it turned out that this first approach, which is, exclusively, erroneous, stretched out in physical science for more than on hundred years.

The original version of the author about the possible existence of real magnetic charges in substance was formed as a result of his neutron diffraction studies of magnetic structures of hexagonal ferrites (period 1968-1971) (Robert, 1971). The displacements of the density of so-called magnetic moments of  $\text{Fe}^{3+}$  ions from atomic nuclei, established in these studies, were later classified by the author as the fact of displacement the real magnetic charges that exist in atomic shells instead so-called of unpaired 3d electrons. Subsequent studies of the author (1971 - present) confirmed his original hypothesis and showed that the magnetic moments are the theoretical prostheses whose purpose is solely to substitute of the real magnetic charges which together with electrons and true antielectrons form atomic shells.

## Acknowledgments

The author is grateful to the technical experts: A. Davydov, N. Koshelev, A. Lomakin, E. Moiseenkov and S. Staritsin who took an active part in conducting the main part experiments related to the detection and study of real magnetic charges in atoms and substance.

## References

- Dirac, P. A. M. (1930). A theory of electrons and protons. *Proceedings of the Royal Society, A126*, 360. <https://doi.org/10.1098/rspa.1930.0013>
- Dirac, P. A. M. (1931). Quantized Singularities in the Electromagnetic Field. *Proceedings of the Royal Society, A133*, 60. <https://doi.org/10.1098/rspa.1931.0130>
- Ehrenhaft, F. (1942). Photophoresis and Its Interpretation by Electric and Magnetic Ions. *Journal of the Franklin Institute, 19*. [https://doi.org/10.1016/S0016-0032\(42\)90311-9](https://doi.org/10.1016/S0016-0032(42)90311-9)
- Maxwell, J. C. (1873). *Treatise on Electricity and Magnetism* (Vol. 1-2). Clarendon Press, Oxford.
- Robert A. Sizov. (1971). Delocalization of the magnetic moment of  $\text{Fe}^{3+}$  ions in Y type hexagonal ferrite at 293°K. *Journal of Experimental and Theoretical Physics, 60*, 1363-1370.

- Robert A. Sizov. (2001). *New Presentation of Nature Magnetism, Gravitation and Nuclear Forces of Bonding*. Akademizdat Center “Science”, Moscow.
- Robert A. Sizov. (2008). *Electric and Magnetic Spinor Particles as Structure-Forming Components of Mass and Electromagnetic Source Gravitation*. Akademizdat-Center “Science”, Moscow.
- Robert A. Sizov. (2011/2012). *Matter, Antimatter and Energo-Medium is Physical Triad of the Real World*. Akademizdat-Center “Science”, Moscow.
- Robert A. Sizov. (2015). Dirac’s “holes” are the true Antielectrons and real particles of Antimatter. *Journal of Modern Physics*, 6(15), 2280-2289. <https://doi.org/10.4236/jmp.2015.615232>
- Robert A. Sizov. (2015). Real Magnetic Charges in the Substance, Ferrogravitation and Technical Levitation. *Journal of Modern Physics*, 6, 1591-1601. <https://doi.org/10.4236/jmp.2015.611161>
- Robert A. Sizov. (2015). Real magnetic poles (magnetic charges) in the Physics of magnetism, gravitation and levitation. *Journal of Modern Physics*, 6(8), 1013-1022. <https://doi.org/10.4236/jmp.2015.68106>
- Robert A. Sizov. (2016). Electromagnetic Shells of Atoms and Periodic System of Elements. *Journal of Modern Physics*, 7(16), 2374-2397. <https://doi.org/10.4236/jmp.2016.716206>
- Robert A. Sizov. (2016). Magnetic and electric charges in Physics and Technology of electromagnetic and magnetoelectric induction. *Journal of Modern Physics*, 8(6), 964-981. <https://doi.org/10.4236/jmp.2017.86061>
- Robert A. Sizov. (2016). World Physical Triad: Matter, Antimatter and “Dark energy” in the Processes of Climatic Changes on the Earth. *Journal of Modern Physics*, 7(6), 558-572. <https://doi.org/10.4236/jmp.2016.76059>
- Robert A. Sizov. (2017). “Electrical” and “Magnetic” Worlds in Universe. *Journal of Modern Physics*, 8(7), 1072-1086. <https://doi.org/10.4236/jmp.2017.87069>
- Robert A. Sizov. (2018). Nuclear Physics with Magnetic Charges. *Journal of Modern Physics*, 9(2), 145-171. <https://doi.org/10.4236/jmp.2018.92010>
- Robert A. Sizov. (2018). Real Magnetic Charges as A Negation of the Electric Magnetism Maxwell and Electrified Dirac’s Monopole. *Phys Astron Int J.*, 2(1), 00043.
- Robert A. Sizov. (2019). Intra-atomic gravitational shielding (lensing), nuclear forces and radioactivity. *Journal of Modern Physics*, 10(01), 59-73. <https://doi.org/10.4236/jmp.2019.101006>
- Robert A. Sizov. (2019). The electrical magnetism of Maxwell (1873) is the “crooked mirror” of physical science. *Applied Physics Research*, 11(3), 49-55. <https://doi.org/10.5539/apr.v11n3p49>

## Appendix

### **The Great delusions in of the physical science (1873-2019) which provoked by to Maxwell’s vicious electromagnetic concept.**

This Appendix presents the most important, from the point of view of the author, misconceptions in physics which were generated by the vicious electromagnetic concept of Maxwell. To each

misconception presented in the article, the author's publication is attributed, in which a thorough interpretation of his physical essence is given.

1. The vicious concept of Maxwell's electric magnetism (Robert, 2015, 2016, 2019).
2. The fictitiousness of concept the magnetic moments electrons, as the alternative to real magnetic poles (magnetic charges) (Robert, 2015, 2008).
3. The fictitiousness of concept electronic vacancies or Dirac holes, as well as the use of positron as the alternative to true antielectrons (Dirac, 1931; Robert, 2018).
4. The vicious concept of electronic shells atoms (Robert, 2016).
5. The defectiveness of the Standard Model, as a result of the absence in its composition of real magnetic charges, as well as of true anti-electrons.
6. The fallacy of the existing concepts of Mass, Matter and Antimatter (Robert, 2011/2012; 2016).
7. The fallacy of the existing concept of particle annihilation in the particle-antiparticle pair (Robert, 2019).
8. The fallacy of the existing concepts of the physics of a gravitational field, which, in reality, is a vortex electromagnetic field (Robert, 2001, 2015).
9. The fallacy of electronic models of chemical bonds (Robert, 2019).
10. The fallacy of the existing concepts of the physics of nuclear forces linking nucleons in atomic nuclei (Robert, 2018, 2019).